



VAIS TECHNOLOGY

www.vaistech.com

Owner's Manual

GSR

SiriusXM Satellite Radio interface

(SXV300 SiriusXM Tuner required)

UNIVERSAL



VAIS
TECHNOLOGY



TOYOTA

DODGE



ACURA



HONDA

CHRYSLER



SUBARU



MAZDA



Jeep



PORSCHE



Mercedes-Benz

| | | |
|---|-----------------------------|-----------|
| Installation | 4 | |
| <i>Vehicle Specific User Interface</i> | Dodge, Chrysler, Jeep, Fiat | 7 |
| | Ford | 9 |
| | GMC, Chevrolet | 11 |
| | Honda, Acura | 13 |
| | Land Rover | 15 |
| | Mazda | 17 |
| | Mercedes-Benz | 19 |
| | Nissan | 21 |
| | Toyota, Scion | 23 |
| User Interface - Channels, Presets, Categories (All Vehicles) | 25 | |
| Warranty | 27 | |

WARNING

DO NOT DISASSEMBLE OR ALTER

Doing so may result in an accident, fire or electric shock

Do not block the airbag

Do not mount product or any added audio and/or video equipment where it can obstruct the operation of any safety devices such as the airbag.

Distraction warning

Do not let product or any added audio and/or video equipment distract you while you are driving.

BEFORE WIRING, DISCONNECT THE CABLE FROM THE NEGATIVE BATTERY TERMINAL

Before starting any installation work, you must wait 90 seconds after turning the ignition switch to the LOCK position and disconnecting the negative (-) terminal from the battery. The supplemental restraint system (airbag) is equipped with a backup power source. If installation work is started less than 90 seconds after disconnection of the negative (-) battery terminal, the SRS may deploy. When the negative (-) terminal cable is disconnected from the battery, the clock and audio systems memory will be erased. Before starting installation work, make a record of the clock and audio systems memory settings. When installation is complete, reset the clock and audio systems to their previous settings. Power tilt, power telescopic steering column, front power seats, power mirrors, and power shoulder belt anchorage are equipped with a memory function. The rear power seat is not equipped with a memory function, and they can make a record of the memory contents. Rear power seat is not equipped with the memory function. When installation is complete, it is necessary to readjust the features to their previous settings. Never use a backup power supply (such as another battery) during installation work to avoid losing these memory settings.

CAUTION

DO NOT SPLICE INTO ELECTRICAL CABLES

Never cut away cable insulation to supply power to other equipment. Doing so will exceed the current carrying capacity of the wire and result in fire or electric shock.

DO NOT ALLOW CABLES TO BECOME ENTANGLED IN SURROUNDING OBJECTS

Cables or wiring that obstruct or get caught on places such as the steering wheel, shift lever, brake pedals, etc. can be extremely hazardous.

DO NOT INSTALL IN LOCATIONS WITH HIGH MOISTURE OR DUST

Moisture or dust may result in product failure.

HAVE THE WIRING AND INSTALLATION DONE BY EXPERTS

The wiring and installation of this product requires special technical skills and experience.

USE ONLY SPECIFIED ACCESSORY PARTS

Use of other than specified parts may damage product internally.

FOLLOW THE OPERATIONAL AND INSTALLATION MANUALS.

YOU SHOULD READ AND FAMILIARIZE YOURSELF THOROUGHLY WITH THE FOLLOWING INFORMATION PRIOR TO INSTALLING AND USING THIS UNIT. IN ADDITION, YOU MUST CAREFULLY READ AND FOLLOW THE INSTALLATION SCHEMATICS/INSTRUCTIONS FOR THE PRODUCT AND THE VEHICLE IN WHICH IT IS BEING INSTALLED. FAILURE TO FOLLOW INSTALLATION INSTRUCTIONS MAY DAMAGE THE PRODUCT AND THE VEHICLE, WILL VOID THE PRODUCT WARRANTY, AND MAY VOID THE VEHICLE WARRANTY

CHECK YOUR LOCAL LAWS

Some States/Provinces or other governmental jurisdictions (such as cities) may have laws that prohibit the operation of a video screen within the sight of the Driver. If you have purchased such a product, you should use the product only in locations where it is legal to do so, and if you do use the product, set up the screen so it is only visible to passengers.

TROUBLESHOOTING

Should this product fail to operate properly, please contact your Dealer or our Customer Service Department at info@vaistech.com.

About SiriusXM Satellite Radio Operation

- The unit may refuse to change the channel if your reception is going ON and OFF. Please wait until your reception stabilizes in order for the unit to allow you to change the channel easily.
- Due to bad reception in some areas, SiriusXM Satellite Radio may not work and/or not able to display text.

What's Included

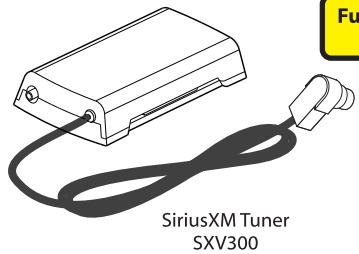
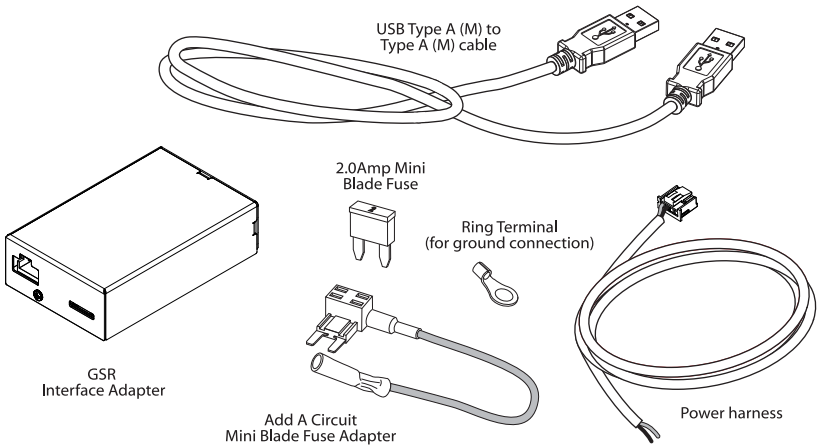

Fuse Adapter is not included in GSR-U01 KIT

Vehicle Antenna and SiriusXM Tuner SXV300 are included in GSR-TKIT only

GSR Connectors and Ports

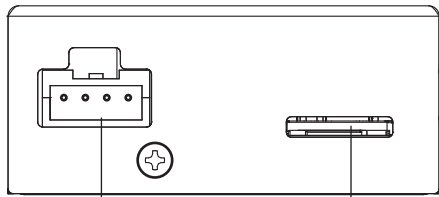
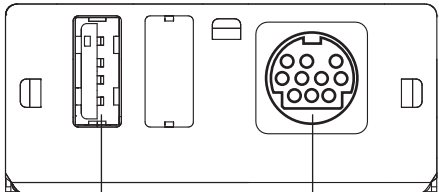

Connecting GSR



CONSTANT BATTERY POWER ONLY

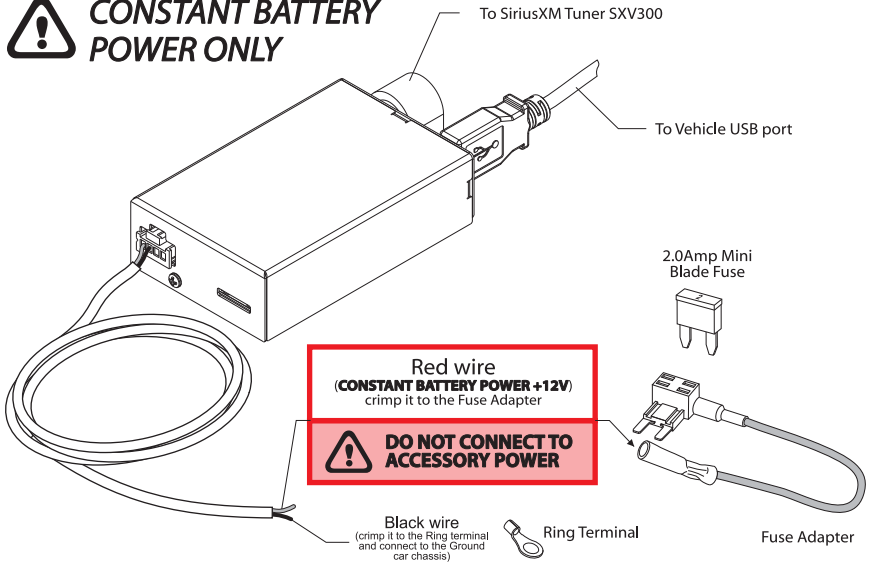

Fuse Adapter is not included in GSR-U01 KIT

Fuse Adapter Connection Diagram

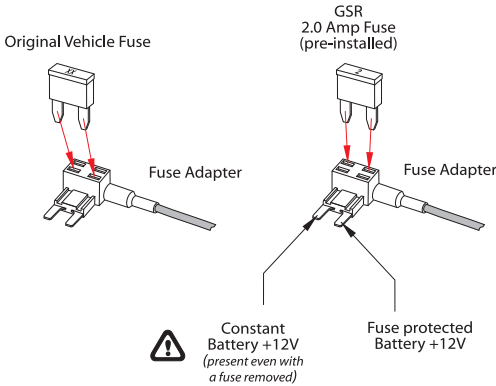

! INFORMATION

GSR is equipped with internal resettable electronic fuse. This allows direct constant Battery +12V connection without fuse if necessary.

! CAUTION

When Fuse Add-on adapter is used for GSR constant +12V connection using the fuse box, located in junction block assembly, make sure you do not utilize any drive operation and/or safety critical fuses, such as Engine Control, Immobilizer System, ABS, Traction Control, Vehicle Stability Control, Cruise Control, Theft Deterrent, Head/Tail Lights fuses.

ATTENTION

We strongly recommend that you install the unit in an easily accessible location, so you can later update the firmware.

Firmware update is required for GSR-U01 kit to operate per specific vehicle. See below for information how to make this unit vehicle specific.

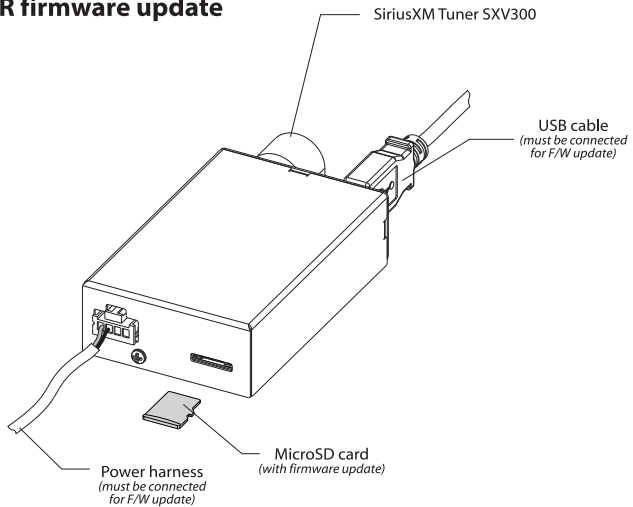
About GSR firmware update

Update instructions YouTube Video can also be viewed here:
<https://www.youtube.com/watch?v=43ngtekQtpo>



Log in to Dealer Portal at www.vaistech.com to download the firmware and update instructions.



Important

2014 Dodge Charger radio shown. Display and controls varies depending on the car models and available equipment.

A



B

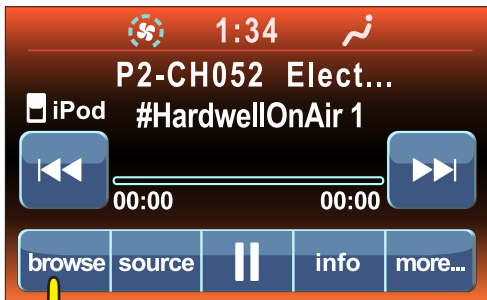

C

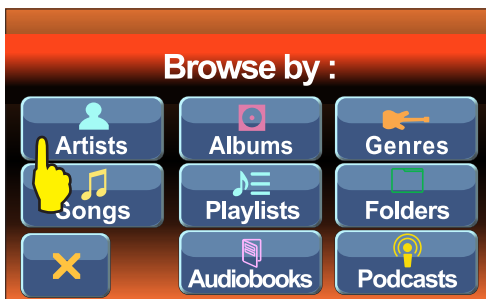

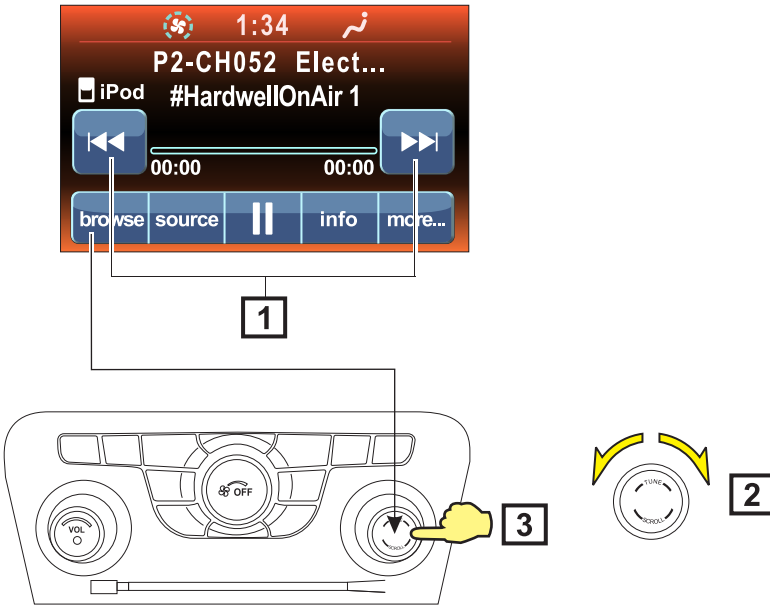

- 1** "Track Seek ►►" and "Track Seek ◄◄" switch to next available channel.
Long Touch on "Track Seek ►►" and "Track Seek ◄◄" switch to next available Preset.
- 2** Use Touch screen or Tuning Knob to "Browse"
- 3** Push Tuning knob to make selection.



Important

2014 Ford Focus radio shown. Display and controls varies depending on the car models and available equipment.

A

Select "USB" Audio Source

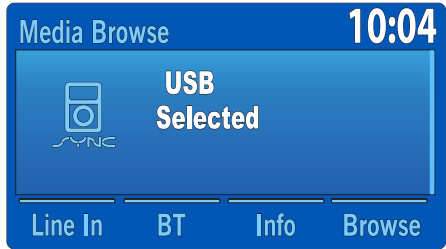
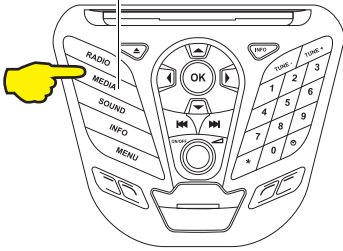

B

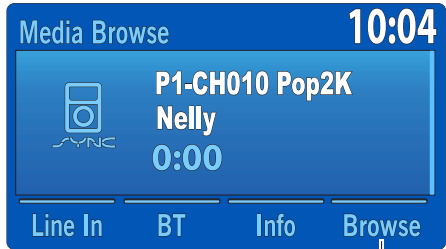
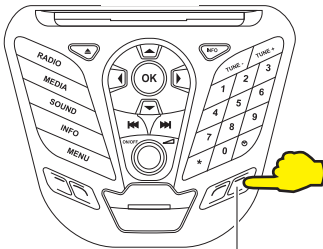

Push to enter Browsing

C

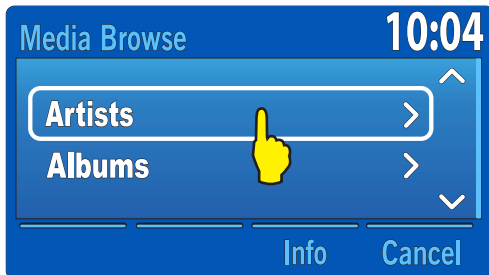

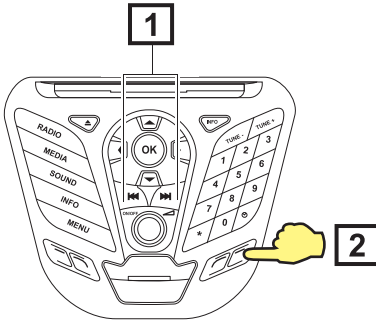

- 1** "Track Seek ►" and "Track Seek ◀" switch to next available channel.
Long Touch on "Track Seek ►" and "Track Seek ◀" switch to next available Preset.
- 2** Push "BROWSE" to enter Browsing.

Known Limitation!

Due to Microsoft SYNC limitation GSR can only Save/Replace/Delete 1 preset at the time.
To Save/Replace/Delete multiple presets factory radio has to be powered down or USB disconnected after each Save/Replace/Delete.

Database Update. WAIT!

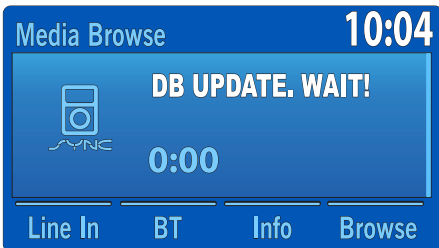

Known Limitation!

Any change in satellite subscription will result in "DB UPDATE. WAIT!" message.
You will need to reselect USB as a source, once it's done updating.

GMC
CHEVROLET**A****B****C**

GMC



CHEVROLET

D

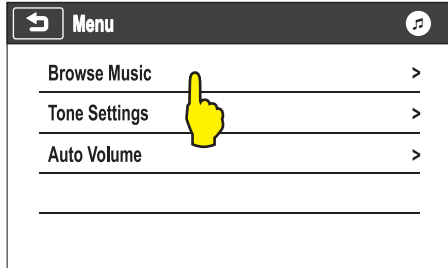

E

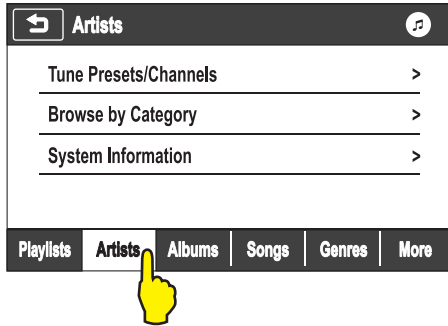

“Track Seek ►|” and “Track Seek ◀|” (on the radio or steering wheel) switch to next available channel.

Long Touch on “Track Seek ►|” and “Track Seek ◀|” switch to next available Preset. 

HONDA

ACURA

Important

2017 Honda Civic radio shown. Display and controls varies depending on the car models.

A

Select "iPod" Audio Source

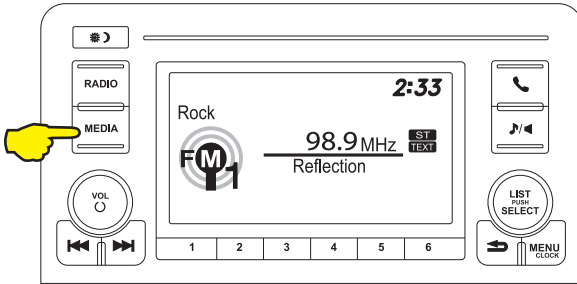

B

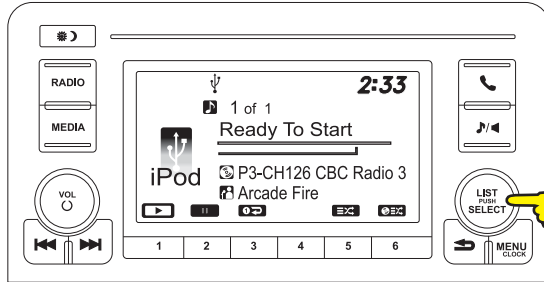

Push "LIST" for Browsing

C

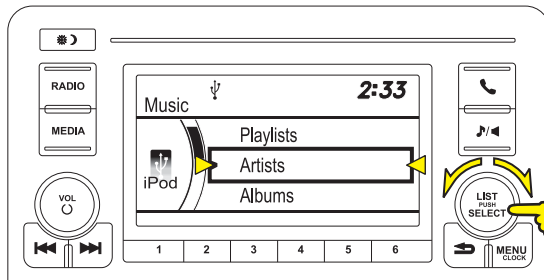

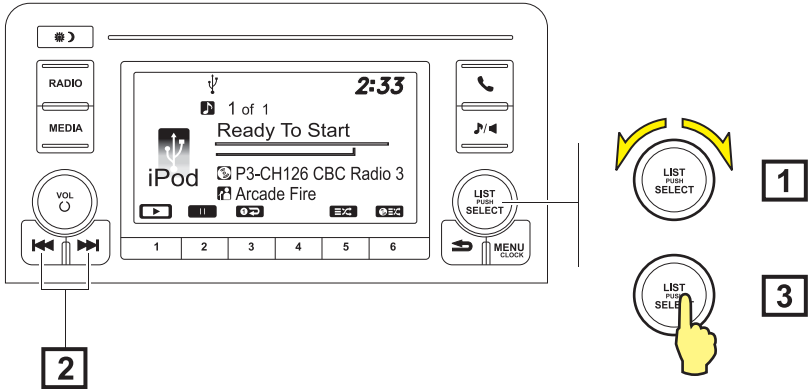

HONDA

ACURA

- 1** Tuning Knob - switch to next available channel, depending on direction of rotation. (Tuning knob may not be available while radio is loading channel list.)
- 2** "Track Seek ►►" and "Track Seek ◄◄" switch to next available channel.
Long Touch on "Track Seek ►►" and "Track Seek ◄◄" switch to next available Preset.
- 3** Push "LIST SELECT" to enter Browsing.

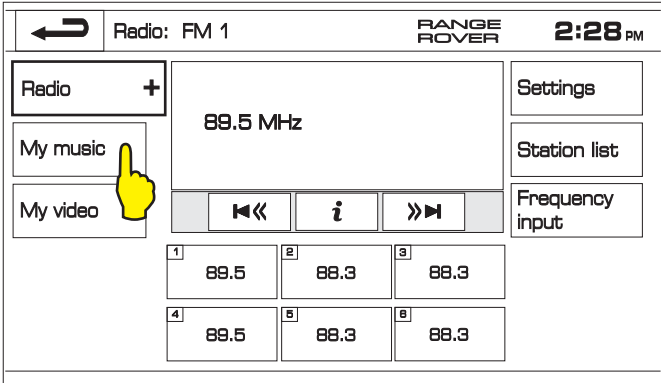

A



Touch to select "iPod" Audio Source

B

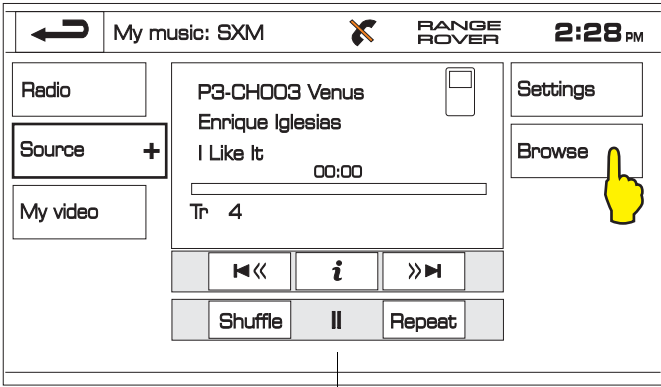

Mute/Unmute



C

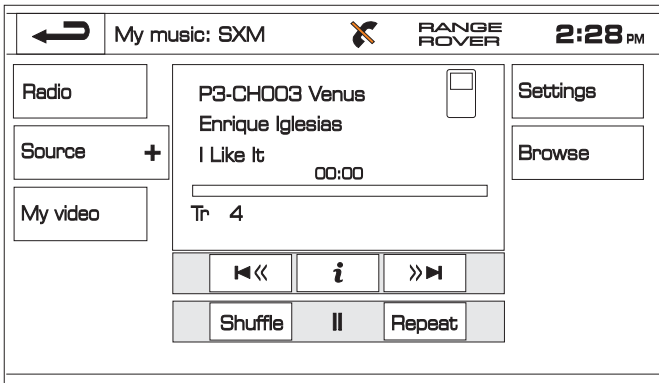

“Track Seek ►►” and “Track Seek ◀◀” (on the radio or steering wheel) switch to next available channel.

Long Touch on “Track Seek ►►” and “Track Seek ◀◀” switch to next available Preset. 

Known Limitation!

Delete/Replace function does not refresh dynamically. In order to refresh “Presets List” after you Delete/Replace a preset. You need to go one level up and then back in to see refreshed list.



A

Touch to select desired Audio Source

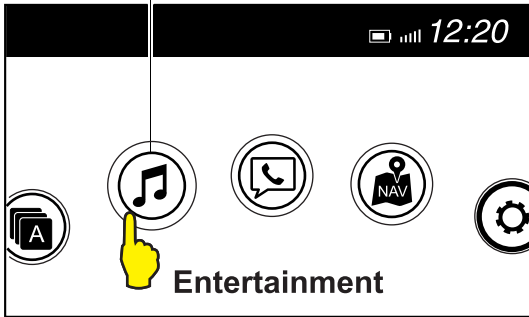

B

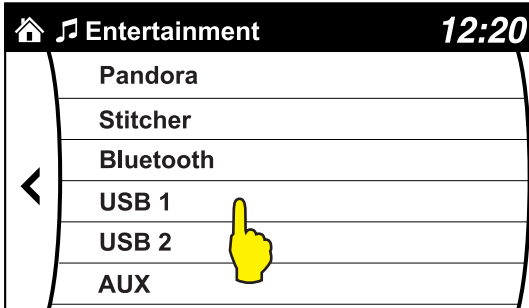

C

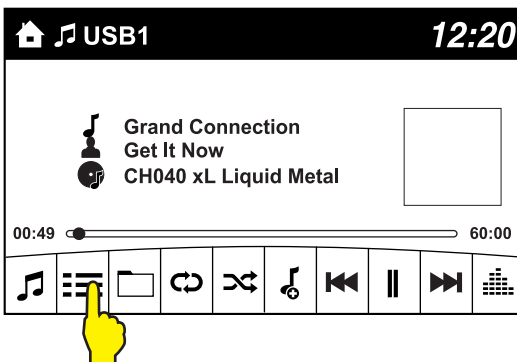



C

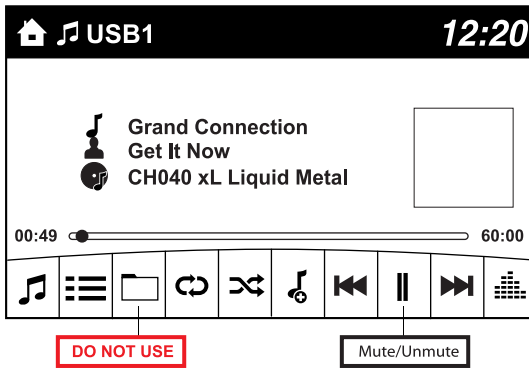
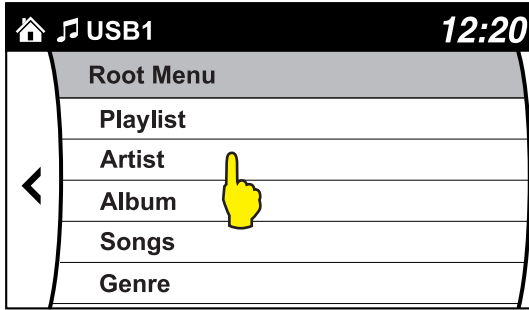

“Track Seek ►” and “Track Seek ◀” (on the radio or steering wheel) switch to next available channel.

Activate “REPEAT” + “Track Seek ►” and “Track Seek ◀” to switch between Presets.





Mercedes-Benz

A

View all Audio Sources available

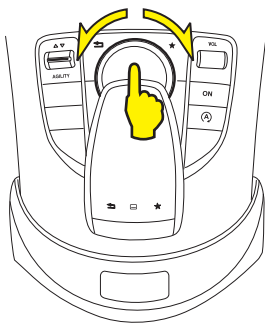
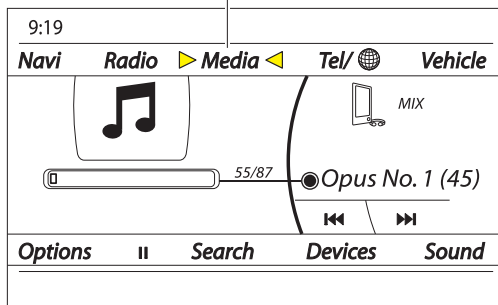

B

Touch to select desired Audio Source

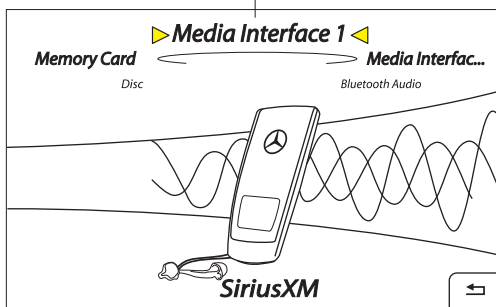
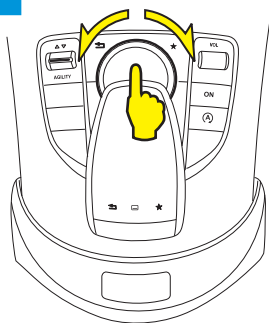

C

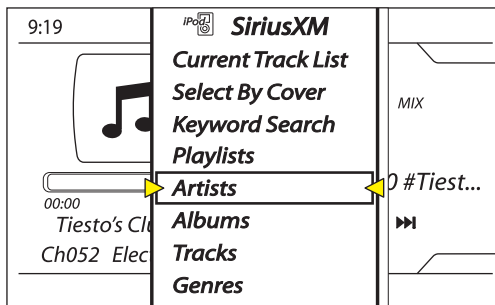
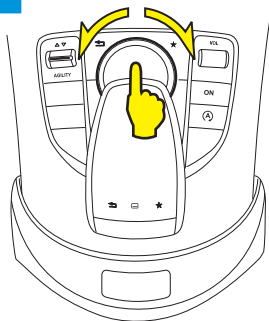



Mercedes-Benz

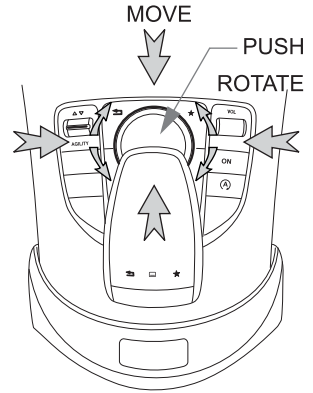
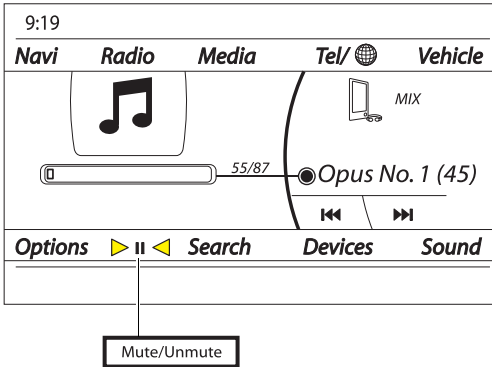

“Track Seek **▶▶**” and “Track Seek **◀◀**” (on the radio or steering wheel) switch to next available channel.

Long Touch on “Track Seek **▶▶**” and “Track Seek **◀◀**” switch to next available Preset.





Important

2015 Nissan Sentra radio shown. Display and controls varies depending on the car models and available equipment.

A

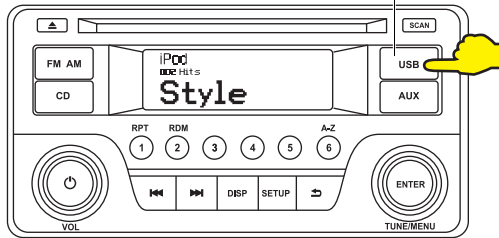

B

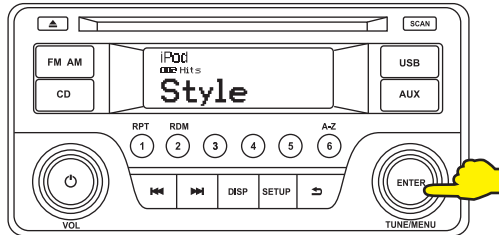

C



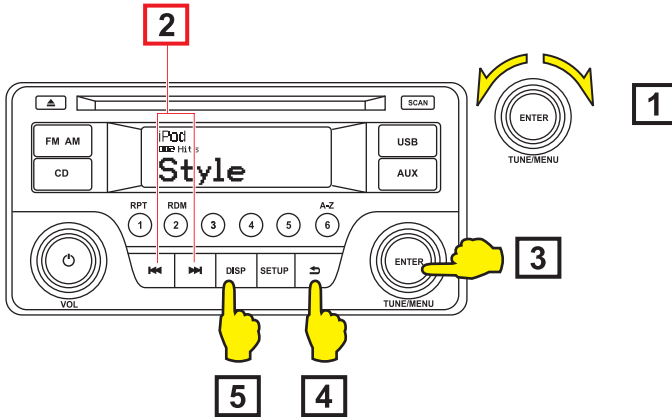

- 1** Tuning Knob - use to make selection in menu.
(Tuning knob may not be available while radio is loading channel list.)
- 2** "Track Seek ►" and "Track Seek ◀" switch to next available channel.
Long Touch on "Track Seek ►" and "Track Seek ◀" switch to next available Preset.
- 3** Push "ENTER" to enter Browsing.
- 4** Push "BACK" button to return from browsing.
- 5** Use "DISP" button to change display mode.



TOYOTA



A

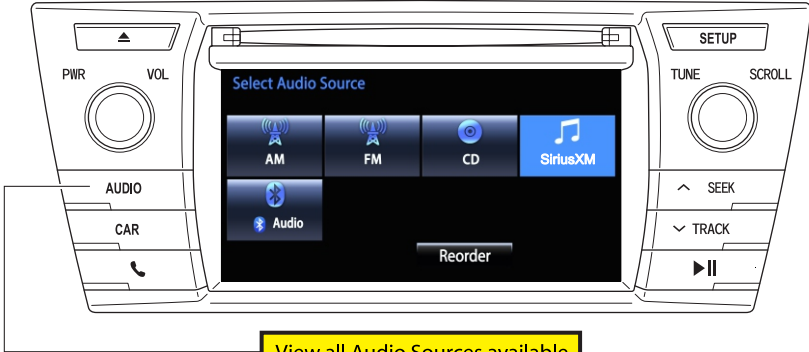

View all Audio Sources available

B

Touch to select "SiriusXM" Audio Source

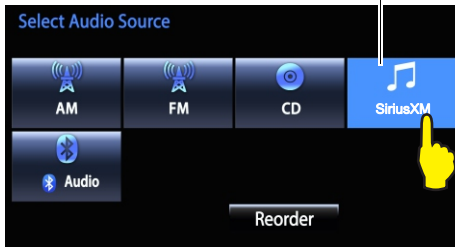

C

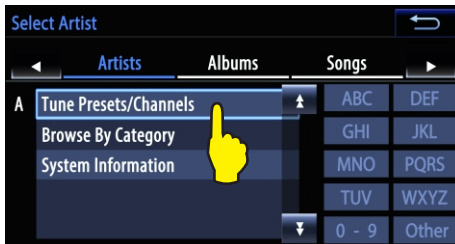

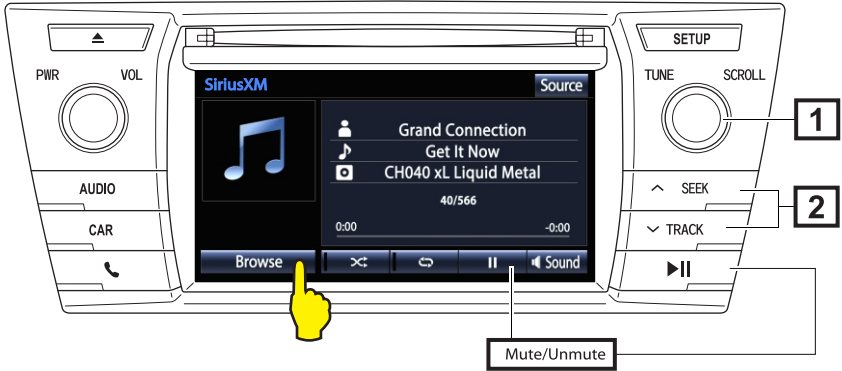

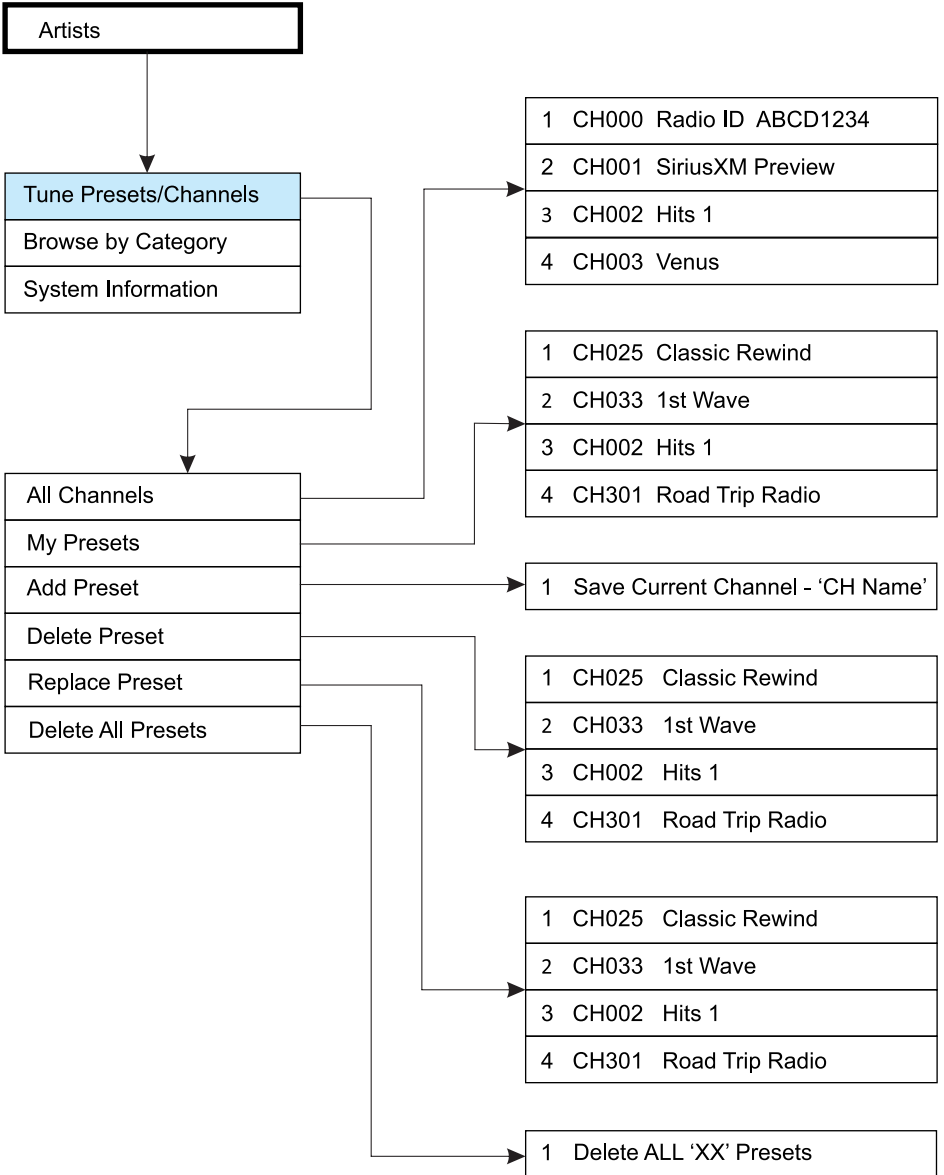

- 1** Tuning Knob - switch to next available channel, depending on direction of rotation.
(Tuning knob may not be available while radio is loading channel list.)
- 2** "Track Seek+" and "Track Seek-" switch to next available channel.
Long Touch on "Track Seek+" and "Track Seek-" switch to next available Preset.

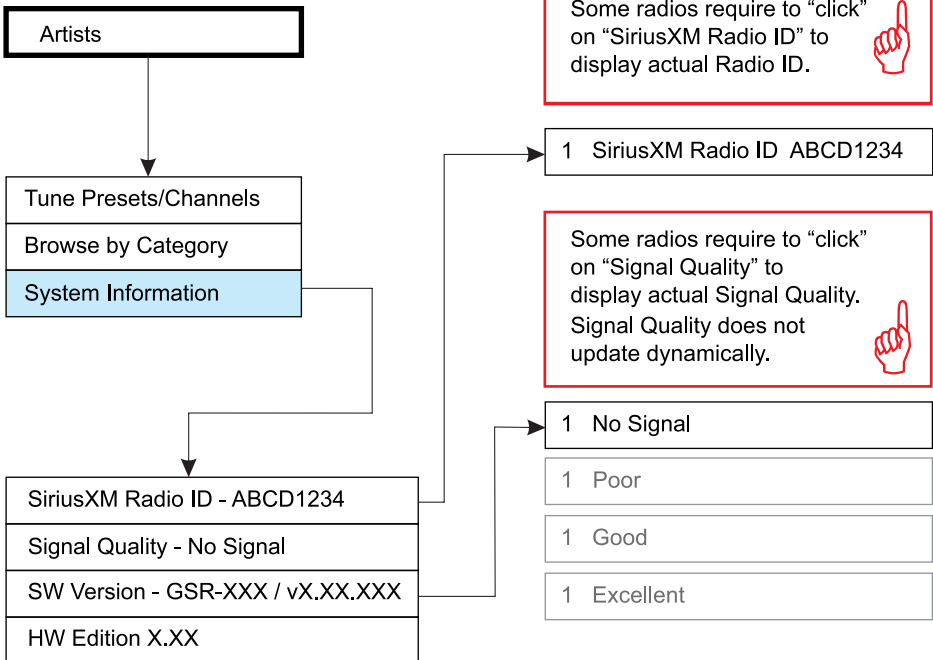
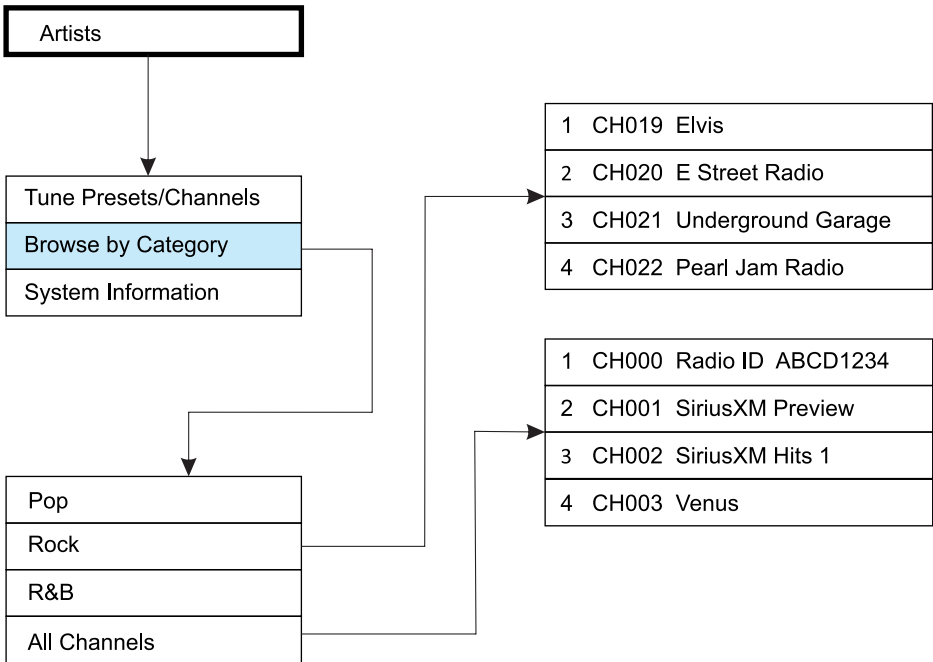



Some radios require to "click" on "SiriusXM Radio ID" to display actual Radio ID. 

Some radios require to "click" on "Signal Quality" to display actual Signal Quality. Signal Quality does not update dynamically. 

LICENSING AGREEMENT, DISCLAIMERS AND LIMITED WARRANTY

VAIS TECHNOLOGY, LLC

LICENSE AGREEMENT

VAIS TECHNOLOGY - GSR and all its related modifications (hereinafter referred to as 'PRODUCT') and its related software; (hereinafter collectively referred to as 'PRODUCTS').

THIS IS A LEGAL AGREEMENT BETWEEN YOU, AS THE END USER, AND VAIS TECHNOLOGY, LLC ("VAIS"). PLEASE CAREFULLY READ THE TERMS AND CONDITIONS OF THIS AGREEMENT BEFORE USING THE VAIS PRODUCTS. BY USING THE VAIS PRODUCTS AND SOFTWARE INSTALLED ON THE VAIS PRODUCTS, YOU ARE AGREEING TO BE BOUND BY THE TERMS OF THIS AGREEMENT. THE AUDIO INTERFACE CONTROLLER AND THE AUDIO VIDEO INTERFACE CONTROLLER ARE ESSENTIALLY THE BRIDGE BETWEEN A VEHICLE, ITS EQUIPMENT, AND ANY 'AFTER-MARKET' EQUIPMENT SUBSEQUENTLY ADDED TO THE VEHICLE BY THE END-USER. THE EQUIPMENT SOLD TO YOU, THE END USER, IF PROPERLY INSTALLED, IS A RESETTABLE TECHNOLOGY, WHICH WILL, UNDER NORMAL CIRCUMSTANCES, AUTOMATICALLY DISCONNECT IN THE EVENT OF ANY MALFUNCTION. SINCE VAIS DOES NOT INSTALL THIS EQUIPMENT, VAIS DISCLAIMS ANY LIABILITY FOR IMPROPER INSTALLATION OF THE VAIS TECHNOLOGY OR THE 'AFTER-MARKET' EQUIPMENT (INPUTS). FURTHER, THE 'END USER' ACKNOWLEDGES THAT THE PRODUCT AND ITS SOFTWARE ARE NOT INHERENTLY DANGEROUS AND DO NOT PROVIDE ANY INHERENT RISKS AND THEREFORE POTENTIAL DAMAGES TO THE END-USER, OTHER THAN 'Fitness for its Purpose'.

Some radio receiver models may cause you to experience some technical difficulties, if the product does not operate properly please contact technical department promptly at info@vaistech.com.

1. GRANT OF LICENSE

VAIS grants to you a non-transferable, non-exclusive license to use the PRODUCT and its software installed on the VAIS product (the "PRODUCTS") and the related documentation solely for your own personal use or for internal use by your business, only on such VAIS PRODUCTS. You shall not copy, reverse engineer, translate, port, modify or make derivative works of the Software contained in the PRODUCT. You shall not loan, rent, disclose, publish, sell, assign, lease, sublicense, market or otherwise transfer the Software in the PRODUCT or use it in any manner not expressly authorized by this agreement. You shall not derive or attempt to derive the source code or structure of all or any portion of the Software in the PRODUCT by reverse engineering, disassembly, recompilation, or any other means. You shall not use the Software in the PRODUCT to operate a service bureau or for any other use involving the processing of data for other persons or entities. VAIS and its licensor(s) shall retain all copyright, trade secret, patent and other proprietary ownership rights to the Software in the PRODUCT. The PRODUCTS are Copyrighted/ Patented and/or at various stages of Pending and **may not** be copied, even if modified or merged with other products. You shall not alter or remove any copyright notice or proprietary legend contained in or on the PRODUCTS. You may transfer all of your license rights in the Software or the PRODUCT, the related documentation and a copy of this License Agreement And Warranty to another party, provided that the party reads and agrees to accept the terms and conditions of this License Agreement And Warranty.

2. OPERATIONAL WARNING AND SAFETY INSTRUCTIONS.

IMPORTANT NOTICE: YOU SHOULD READ AND FAMILIARIZE YOURSELF THOROUGHLY WITH THE FOLLOWING INFORMATION PRIOR TO INSTALLING AND USING THE – GSR and all its related modifications and its related software (THE "PRODUCTS").

IN ADDITION, YOU MUST CAREFULLY READ AND FOLLOW THE INSTALLATION SCHEMATICS/INSTRUCTIONS FOR THE PRODUCT AND THE VEHICLE IN WHICH IT IS BEING INSTALLED. FAILURE TO FOLLOW INSTALLATION INSTRUCTIONS MAY DAMAGE THE PRODUCT AND THE VEHICLE AND WILL VOID THE PRODUCT WARRANTY AND MAY VOID THE VEHICLE WARRANTY. (A copy of the installation schematics is included with the Product and can also be found on the VAIS TECHNOLOGY website at www.vaistech.com.)

FAILURE TO ABIDE BY THESE OPERATIONAL WARNINGS AND SAFETY INSTRUCTIONS COULD RESULT IN SERIOUS BODILY INJURY OR DEATH. IN ADDITION, FAILURE TO FOLLOW THESE INSTRUCTIONS MAY VOID THE PRODUCT WARRANTY AND COULD BECOME A BASIS FOR LIABILITY ON THE PART OF THE VEHICLE OPERATOR IN THE EVENT OF AN ACCIDENT WHICH RESULTS IN INJURY TO PERSONS OR PROPERTY. UNDER NO CIRCUMSTANCES WILL VAIS OR ITS IMMEDIATE AGENTS OR PRINCIPALS, BE LIABLE, FOR DAMAGES INCURRED TO THE PRODUCTS, THE VEHICLE OR ITS PASSENGERS, OR OTHER THIRD-PARTIES AS A RESULT OF FAILURE TO FOLLOW VAIS'S INSTALLATION INSTRUCTIONS.

A COPY OF THE 'OPERATIONAL WARNINGS AND SAFETY INSTRUCTIONS' IS TO BE KEPT WITH THE VEHICLE AT ALL TIMES.

3.DISCLAIMER AND LIMITATION OF WARRANTIES.

(A) EXCEPT AS OTHERWISE CONTAINED HEREIN, the PRODUCTS and related documentation are provided to you, "AS IS". IN NO EVENT SHALL VAIS BE LIABLE FOR ANY DAMAGES, CLAIM OR LOSS INCURRED BY YOU (INCLUDING WITHOUT LIMITATION, COMPENSATORY, INCIDENTAL, INDIRECT, SPECIAL, CONSEQUENTIAL, OR EXEMPLARY DAMAGES, LOST PROFITS, LOST SALES OR BUSINESS, EXPENDITURES, INVESTMENTS, OR COMMITMENTS IN CONNECTION WITH ANY BUSINESS, LOSS OF ANY GOODWILL, OR DAMAGES. THE TERM 'INCIDENTAL DAMAGES' REFERS TO THE EXPENSES OF TRANSPORTING THE PRODUCTS TO THE VAIS SERVICE CENTER, LOSS OF THE END-USERS [ORIGINAL PURCHASER'S] TIME, LOSS OF THE USE OF THE PRODUCT, BUS FARES, CAR RENTALS OR OTHER COSTS RELATED TO THE CARE AND CUSTODY OF THE PRODUCT. THE TERM 'CONSEQUENTIAL DAMAGES' REFERS TO THE COST OF REPAIRING OR REPLACING OTHER PROPERTY, WHICH IS DAMAGED WHEN THIS PRODUCT DOES NOT WORK PROPERLY.) RESULTING FROM THE USE OR INABILITY TO USE THE PRODUCTS, INCLUDING ANY DAMAGES INCURRED DUE TO THE NEGLIGENT OPERATION OF A MOTOR VEHICLE, IN CONJUNCTION WITH THE USE OF SAID PRODUCTS. THE END-USER ACKNOWLEDGES ITS RESPONSIBILITY FOR THE USE OF THE PRODUCT. THE ADDITION OF VAIS PRODUCTS AND ANY AFTER-MARKET EQUIPMENT MAY ENHANCE THE VALUE OF A VEHICLE OR CAUSE A THIRD-PARTY TO ILLEGALLY ATTEMPT TO REMOVE THE PRODUCTS AND AFTER-MARKET EQUIPMENT. VAIS DISCLAIMS ANY LIABILITY RELATED TO SUCH THEFT AND POTENTIAL DAMAGE TO PROPERTY. IT IS THE END-USERS RESPONSIBILITY TO PROTECT ITS OWN PROPERTY. THE END-USER FURTHER ACKNOWLEDGES THAT THE OPERATION OF A MOTOR VEHICLE IS AN INHERENTLY DANGEROUS ACTIVITY, AND BY ITS USE OF VAIS'S PRODUCTS, ACKNOWLEDGES THAT THE PRODUCTS ARE REMOTELY RELATED TO SAID MOTOR VEHICLE OPERATION, AND THUS ANY DAMAGES CAUSED TO THE DRIVER OF THE VEHICLE, THE VEHICLE ITSELF OR ANY THIRD-PARTY AND ITS PROPERTY IS NOT THE RESPONSIBILITY OF VAIS, ITS AGENTS OR ITS PRINCIPALS AND IS THE SOLE RESPONSIBILITY OF THE DRIVER OF SAID VEHICLE.

YOU, THE END-USER, OR ANY OTHER DRIVER OF THE VEHICLE, IS SOLELY RESPONSIBLE FOR THE SAFE OPERATION OF THE VEHICLE AND THE SAFETY OF BOTH YOU AND THE PASSENGERS. FOR SAFETY PURPOSES, THE PRODUCT SHOULD NOT BE USED FOR THE DRIVER'S ENTERTAINMENT, WHILE THE VEHICLE IS BEING DRIVEN. SUCH USE COULD BE A DISTRACTION TO THE DRIVER, WHICH COULD CAUSE AN ACCIDENT LEADING TO SERIOUS INJURY OR DEATH. IF YOU, THE END-USER ALLOW ANOTHER PERSON TO USE THE VEHICLE, IT IS YOUR RESPONSIBILITY TO THOROUGHLY BRIEF THAT OTHER USER, ON THE SAFETY REQUIREMENTS FOR OPERATING THE VEHICLE AND THE PRODUCTS INSTALLED THEREIN.

(B) SAID DISCLAIMERS SHALL APPLY TO THE USE OF SAID PRODUCTS, EVEN IF VAIS HAS BEEN INFORMED OF, KNEW OF, OR SHOULD HAVE KNOWN OF THE LIKELIHOOD OF SUCH DAMAGES. THIS LIMITATION APPLIES TO ALL CAUSES OF ACTION IN THE AGGREGATE, INCLUDING WITHOUT LIMITATION: BREACH OF CONTRACT, BREACH OF WARRANTY, NEGLIGENCE, STRICT LIABILITY, MISREPRESENTATION AND OTHER TORTS. IF VAIS'S WARRANTY DISCLAIMER OR LIMITATION OF LIABILITY SET FORTH IN THIS AGREEMENT SHALL, OR FOR ANY REASON WHATSOEVER, BE HELD UNENFORCEABLE OR INAPPLICABLE, YOU AND ANY OTHER END USER AGREE THAT VAIS'S LIABILITY SHALL NOT EXCEED (50%) OF THE PRICE PAID FOR THE ENCLOSED VAIS PRODUCT.

Some states do not allow the exclusion or limitation of incidental or consequential damages, so the above limitation or exclusion may not apply to you. This Warranty Disclaimer and Limitation of Liability shall not be applicable to the extent that any federal, state or local law, which cannot be preempted, prohibits any provision of this Warranty.

(C) Some States/Provinces or other governmental jurisdictions (such as cities) may have laws that prohibit the operation of a video screen within the sight of the Driver. If you have purchased such a product, you should use the product only in locations where it is legal to do so, and if you do use the product, set up the screen only where it may be visible to passengers only. Although VAIS strongly recommends that Products not be used while the vehicle is in motion, it is your responsibility to determine whether the product can be used in any given location. Any use of the PRODUCTS where it is illegal to do so, may be used against you as evidence of negligence in the event of an auto accident or other traffic infraction.

4. THIRTY (30)- DAY MONEY BACK WARRANTY ONLY IF PURCHASED DIRECT FROM VAIS.

Any Product purchased directly from VAIS, referencing a **Return Authorization Number (RAN)** during the Thirty-(30) day period following shipment by VAIS, may be returned for a full refund of the purchase price actually paid, only if you have received damaged, defective or incorrectly shipped merchandise. The RAN number may be obtained from **VAIS's Customer Support at (720) 733-2348**, and is valid for only thirty- (30) days from its issuance. Said RAN must be noted on the outside of the returned PRODUCTS' packaging. The PRODUCTS must be returned in its original packaging, intact, without any evidence of tampering with the PRODUCTS or physical damage caused by the Customer (End-User).

WE WOULD STRONGLY RECOMMEND THAT THE ITEM BE SHIPPED INSURED, SINCE THE RISK OF LOSS DURING SHIPPING IS WITH THE END-USER. Re-stocking Fees may apply. Damage Fees if deemed caused by the End-User may apply. SHIPPING AND HANDLING OF THE END-USER IS NOT REFUNDABLE AND MUST BE PREPAID, FOR THIS WARRANTY TO BE APPLICABLE. END-USER SHALL ASSUME ALL RISK OF LOSS FOR THE SHIPPING OF THE PRODUCTS TO VAIS. **PLEASE ALLOW UP TO EIGHT (8) WEEKS FOR VAIS TO CREDIT YOUR ACCOUNT.**

5. LIMITED WARRANTY.

VAIS warrants that the PRODUCTS will be free from defects in materials and workmanship for a period of ONE (1) YEAR from the date of purchase. VAIS's sole obligation under this warranty is to repair or replace at VAIS's option, any PRODUCTS that VAIS shall have determined to be defective. Any replacement of parts, shall at the option of VAIS and at no additional charge to the end-user, be new or rebuilt/re-engineered replacement parts. Any replacement of PRODUCTS shall be with new or remanufactured equivalent PRODUCTS. The End-User is responsible for all shipping costs to VAIS, in connection with warranty service. VAIS will not be liable for any defects arising out of any modification of the PRODUCTS, or misuse, neglect, improper installation not in accordance with the specifications provided by VAIS, or if the product is used in violation of any applicable local, state or federal laws. It is the End Users responsibility to ascertain the existence and applicability of any local laws to the operation of the PRODUCTS, in any location where the PRODUCTS are being used. other causes beyond Seller's reasonable control.

A. WHO PERFORMS VAIS TECHNOLOGY'S WARRANTY COMPLIANCE.

VAIS Technology's professional technical department will perform VAIS warranty obligations.

B. WHAT YOU MUST DO.

To obtain warranty performance, you must take the PRODUCTS, or deliver the PRODUCTS freight prepaid, to a VAIS Technology Authorized Service Center. If shipped, the PRODUCTS must be packaged so that it is protected from possible shipping damage. VAIS Technology will ship the PRODUCTS to you when warranty performance is completed. VAIS Technology will pay for shipping the PRODUCTS to you, if the product was repaired under the warranty and the Product was received by the Service Center during the warranty period, in which case the Product will be returned to you freight prepaid by VAIS. You must present to the Service Center, or include with your shipment, a dealer's bill of sale, or other original evidence, showing the date and place of purchase and describing the Product purchased to establish warranty eligibility. Be sure to include your return address and a written description of the problem and a daytime telephone number where you can be reached should the need arise.

SHIP TO: VAIS Technology
8811 American Way, Suite 125
Englewood, CO
80112

ATTENTION: SERVICE DEPARTMENT

For your own protection, you should obtain a proof of delivery receipt. Return shipping (that is, shipping back to the customer following repair or replacement), will be paid by the Seller unless repair or replacement is determined not to be covered by the warranty.

C. WHAT THE WARRANTY DOES NOT COVER. VAIS shall have no liability or obligation to Purchaser with respect to any PRODUCTS requiring service during the warranty period which is subjected to any of the following: abuse, improper operation, negligence, accident, modification, improper connections, failure of the end-user to follow the operating procedures outlined both herein, and in any user's manual, attempted repair by non-qualified personnel, Company or Association; operation of the Product outside of the published environmental and electrical parameters, or if such Product's original identification (trademark, serial number) markings have been defaced, altered, or removed. VAIS excludes from warranty coverage Products which have not been sold by VAIS or an Authorized VAIS Dealer to the Purchaser. VAIS also excludes from warranty coverage Products sold outside of the United States. **All wires and connectors provided otherwise in any documentation or license agreement furnished with the PRODUCTS.**

Other Items Not covered Pursuant to this Warranty:

1. Damage occurring during shipment of the product to VAIS for repair (claims must be presented to the carrier);
2. Any cost or expense related to the removal or reinstallation of the product;
3. Any Products which have been adjusted, altered or modified without VAIS's consent;
4. Any Products that has been determined to contain an excessive amount of dust or dirt and any product that contains any other contaminants including liquid or foreign objects.

REPAIR OR REPLACEMENT AS PROVIDED IN THIS WARRANTY IS THE PURCHASER'S EXCLUSIVE WARRANTY REMEDY. IMPLIED WARRANTIES, INCLUDING THE WARRANTIES OF MERCHANTABILITY AND OF FITNESS FOR A PARTICULAR PURPOSE, SHALL NOT EXTEND BEYOND THE DURATION OF THE APPLICABLE PARTS WARRANTY PERIOD AND NO PERSON, COMPANY OR ASSOCIATION (INCLUDING AUTHORIZED DEALERS) IS AUTHORIZED TO ASSUME FOR VAIS ANY OTHER LIABILITY IN CONNECTION WITH THE SALE OF THE PRODUCT.

D. ALL WARRANTIES EXPRESS OR IMPLIED, ARE HEREBY DISCLAIMED BY VAIS, AND ANY SUCH WARRANTY IS DEEMED VOID, IN THE EVENT THE END-USER ATTEMPTS TO MODIFY THE PRODUCT OR PRODUCTS IN ANY WAY.

In addition, some states, do not allow limitations on how long an implied warranty lasts or the exclusion or limitation of incidental or consequential damages, so the above limitations or exclusion may not apply to you. This warranty gives you specific legal rights and you may have other rights, which may vary, from state to state. **THE ABOVE WARRANTY TERMS AND CONDITIONS ARE VALID ONLY IN THE U.S.A.**

IMPORTANT STEPS TO SAFEGUARD YOUR DATA AND PROPERTY :

Be sure to remove all third-party after market equipment, options, alterations, and attachments not warranted by VAIS Technology before sending the Product to VAIS for warranty service. **VAIS IS NOT LIABLE FOR ANY LOSS OR DAMAGE TO THESE ITEMS.**

6. OTHER PROVISIONS:

A. **INDEMNIFICATION OF VAIS, ITS AGENTS AND EMPLOYEES.** By Purchasing, Installing and Using the Products, You, the End-User, agree to indemnify, defend and hold harmless, VAIS, and its Affiliates, Directors, Officers, Agents and Employees from any Liabilities, Damage, Loss, Claim and Expense (including reasonable Attorney's Fees) arising out of the installation and use of the Products.

B. **GOVERNING LAW, THIS AGREEMENT,** and all Purchases hereunder shall be governed by, and construed under the laws of the State of Colorado, without regard to conflicts of law rules. You agree that the Courts of Colorado shall have exclusive jurisdiction over the Parties, for all disputes. Venue shall lie exclusively in either: (i) Arapahoe County District Court; or the U.S. District Court, District of Colorado.

C. **NOT FOR RESALE NOR EXPORT ASSURANCES.** You, the End-User certifies and agrees that the Products are being Purchased for the End-Users own use, and not for resale. The End-User further agrees that he/she/it will not remove components from Product for resale, unless he/ she/ it becomes certified as an official dealer of VAIS and enters into the appropriate 'Distribution Agreements' required by VAIS technology. The End-User further agrees that neither the software, nor any other technical data received from VAIS, nor the direct Product thereof, will be exported outside the United States, except as authorized and as permitted by VAIS and in accordance with the laws and regulations of the United States. If the software or Products rightfully obtained by you outside of the United States, you agree that you will not export the Software, Products, nor other technical data, received from VAIS; except as authorized and as permitted by VAIS, and in accordance with the laws and regulations of the United States. VAIS and the End-User recognize that violation of these provisions will result in damages to VAIS, in a substantial amount, which is not easily determined. If these provision are violated, the End-User shall be liable to VAIS in the amount of \$100/day, as liquidated damages and not as a penalty, commencing with the first day in which the end-user violates this provision and ending on the day in which such Products or its parts are recovered by VAIS.

D. **FORCE MAJEURE.** VAIS Technology shall not be liable for any delay or failure in performance caused by or resulting from acts of God, fire, flood, storms, earthquakes, tornados, other acts of nature, any accidents, riots, wars, government intervention, embargoes, strikes, labor difficulties, equipment failures, or any other causes beyond the control of VAIS Technology. Quantities are subject to availability. In the event of shortage, VAIS Technology may allocate sales and deliveries in its sole discretion.

E. **WAIVER.** Failure of VAIS Technology to insist upon strict performance of any provisions hereof shall not be deemed a waiver of its right and remedies.

F. **SEVERABILITY.** In the event that any of the provisions, or portions thereof, of this Agreement are held to be unenforceable or invalid by any court or tribunal of competent jurisdiction, the validity and enforceability of the remaining provisions, or portions thereof, shall not be affected thereby, and effect shall be given to the intent manifested by the provisions, or portions thereof, held to be enforceable and valid.

G. **CONSTRUCTION:** Throughout this Agreement the singular shall include the plural, and the plural shall include the singular, and masculine shall include the feminine wherever the context so requires.

H. **COMPETENCY OF THE PARTIES.** Each party is legally competent and fully authorized to execute this Agreement.

I. **OPPORTUNITY TO REVIEW AGREEMENT WITH COUNSEL OF PARTIES OWN CHOOSING.** You, the End-User acknowledge that YOU have had every right to consult a licensed attorney, and have done so to the extent of your desires, prior to entering into this Agreement, and: (a) has fully and carefully read and considered this Agreement prior to its execution; (b) has been sent to, or has had the opportunity to be fully apprised by his or her attorney of the legal effect and meaning of this document and all of its terms and conditions; (c) has had the opportunity to make whatever investigation or inquiry he/she deems necessary or appropriate in connection with the subject matter of this Agreement; (d) has been afforded the opportunity to negotiate as to any and all terms of this Agreement; and (e) is executing this Agreement voluntarily, free from any undue influence, coercion, duress or fraud of any kind.

J. **BINDING EFFECT:** Upon execution, this Agreement shall be binding and fully enforceable, and shall inure to the benefit of the parties hereto, their successors, personal representatives and heirs.

K. **NOTICES:** All notices, as may be required by this Agreement, shall be sent to the respective parties at the addresses set forth below. Appropriate registered or certified mailing to the parties may modify the place of notice.

L. **ENTIRE AGREEMENT.** These terms and conditions constitute the entire and exclusive agreement between you, the End-User and VAIS Technology, concerning the Products, and your purchase hereunder, and supercede all statements or other agreements, whether oral or written, between you and VAIS Technology. No change in this Agreement shall be effective, unless agreed to in writing by both you, the end-user and VAIS.

IF YOU DO NOT AGREE WITH THESE TERMS, PLEASE RETURN THE VAIS PRODUCTS (INCLUDING THE SOFTWARE* AND ANY WRITTEN MATERIALS) IN ORIGINAL CONDITION, AND IN ORIGINAL PACKAGE (INCLUDING SHIPPING BOX, AND ALL PACKAGING BELONGINGS USED FOR SECURE SHIPPING) WITHIN FIVE (5) BUSINESS DAYS OF RECEIPT OF THE PRODUCTS, TO THE PLACE FROM WHICH YOU PURCHASED THEM, FOR A FULL REFUND OF THE PURCHASE PRICE OF THE VAIS PRODUCTS.

* VALID FOR SPECIFIC VAIS PRODUCTS ONLY



Other Products From VAIS Technology

2001-2009 Toyota/Lexus

Satellite Radio Interface

2001-2012 Toyota/Lexus

Bluetooth Audio Streaming Device

2001-2012 Toyota/Lexus

Auxiliary Input Device

2001-2012 Toyota/Lexus

USB iPhone, iPod and iPad Input Device

2006-2017 Toyota/Lexus

Navigation & Video Unlock Device

LiftGo Handsfree Lift Gate/ Trunk Opener

*Demo videos available
at www.youtube.com/vaistech*

