

NAV-TV

INTERFACING THE FUTURE

3950 NW 120th Ave, Coral Springs, FL 33065 TEL 561-955-9770 FAX 561-955-9760

Mazda-CAM 2

Reverse camera kit for select Mazda

NTV-KIT812



BHM
04/06/17
NTV-DOC294

Overview

The Mazda-CAM 2 integrates a single reverse camera into the factory screen on select 2016 & 2017 Mazda vehicles equipped with the MAZDA-CONNECT infotainment system (7" touch screen, knob control on lower console). This kit is not currently Plug & Play and must be manually wired behind the radio (screen assembly).

Kit Content

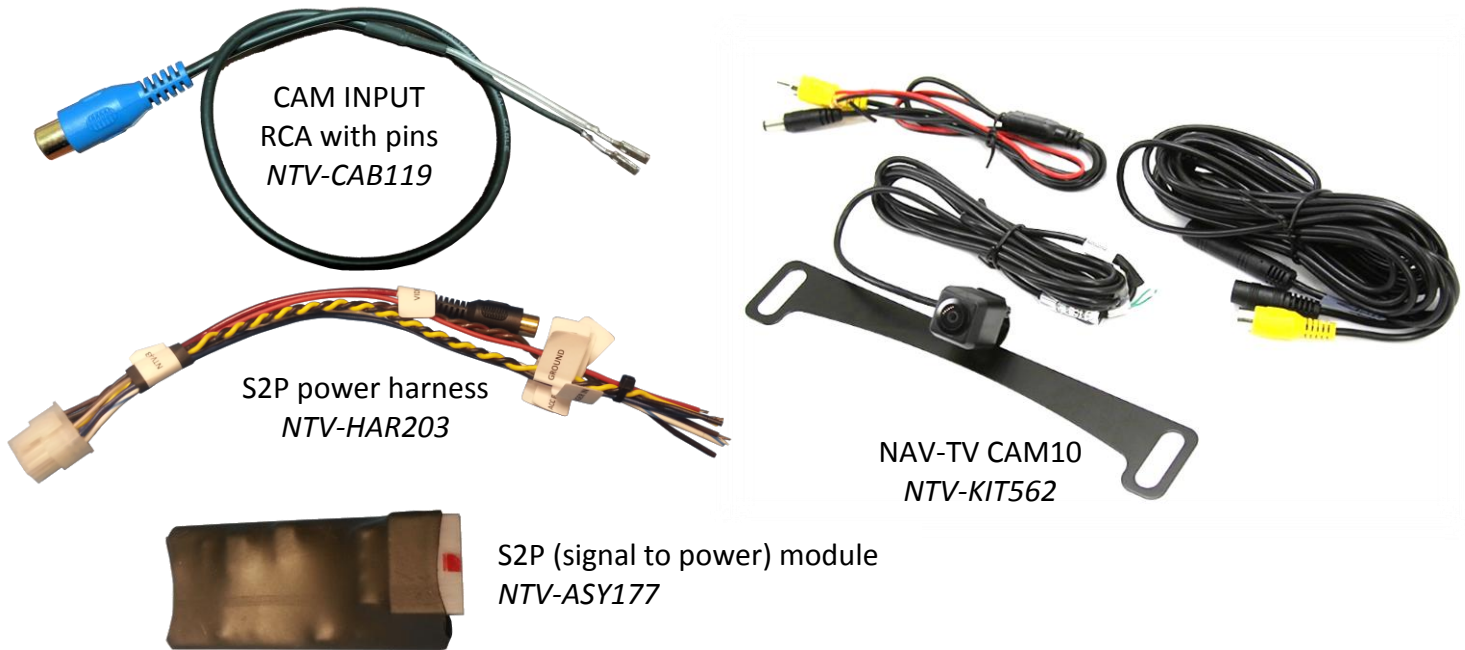

S2P Pin out

PIN #	Description	Color
1	CAN HI	Brown/Red
2	12v (+) Constant input	Yellow
3	12v (+) OUT (when triggered)	Red
4	Low current (+) input	White/Blue
5	CAN LO	Brown
6	Chassis Ground (-) input	Black
7	RCA Video signal	RCA
8	Low current (-) input	Blue

Mazda-CAM 2 Compatibility

Year	Compatible
2014	3
2015+	3, 6, CX-3, CX-5, MX-5

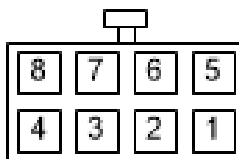

Wire Side



Vehicle must be equipped with touch screen and knob-controller on lower dash.



Agreement: End user agrees to use this product in compliance with all State and Federal laws. NAV-TV Corp. would not be held liable for misuse of its product. If you do not agree, please discontinue use immediately and return product to place of purchase. This product is intended for off-road use and passenger entertainment only.

Mazda-CAM 2 Installation

NOTE: Install S2P and TEST camera temporarily before drilling any hole into the bumper to run camera line!

NOTE: this dash removal is for a MX-5 (Miata), though other vehicles may be similar.

1. **Partially remove** the dash panel shown beginning on the driver's side.
NOTE: If you want to fully remove this panel, you must first remove:
 - a. *The passenger A-pillar*
 - b. *The passenger sill panel*
 - c. *The passenger kick panel*
 - d. *The 10mm bolt securing the dash panel (from step 1)*



2. Next, pull the vent assembly with hazard switch out towards you. It is secured to the sub-dash with clips only. Disconnect the hazard switch.



3. Next, pull the cluster shroud (with vents) out towards you. They are secured to the sub-dash with clips only. Disconnect the sensor harness and set this panel aside.



4. Remove the 10mm bolt securing the screen/radio assembly into the sub-dash. After this bolt has been removed, it is secured with clips only. Pull with medium-force and it should pop out.
5. Disconnect all radio plugs and set the radio aside.



The two plugs to be tied into for this install are circled below. The S2P module included in this kit is required to power on the camera when the door is unlocked (unlocking the door wakes the CAN-BUS, thus powering the camera so that it is ready when the vehicle is started). If the S2P is *not installed*, the camera displaying while in reverse gear will be *intermittent*.

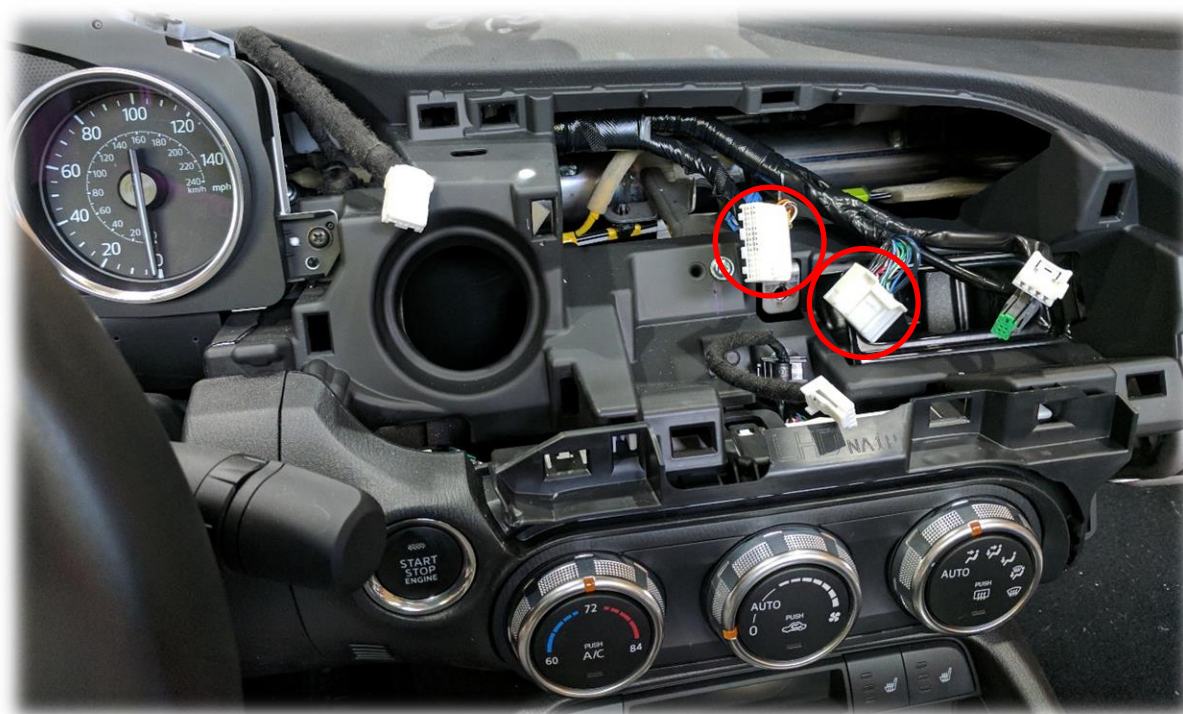

Agreement: End user agrees to use this product in compliance with all State and Federal laws. NAV-TV Corp. would not be held liable for misuse of its product. If you do not agree, please discontinue use immediately and return product to place of purchase. This product is intended for off-road use and passenger entertainment only.

6. From the provided S2P power harness, splice (solder) the following wires to the OEM 18-pin power connector wiring:

S2P pin	S2P Color & Description	OEM Vehicle pin	OEM Color
6	Black (ground)	12	Black
2	Yellow (12v)	17	Black/Blue
1	CAN HIGH	3	White
5	CAN LOW	13	Red



7. Connect the S2P module to the S2P power connector you just wired to the car (if it isn't already).
8. The OEM Mazda 28-pin connector is where the provided RCA (with pins) must be inserted. If the location indicated is already populated with wires, cut the pins off the provided RCA and splice the signal and shield into the same location as shown.

8.a. Begin with 28-pin connector like this

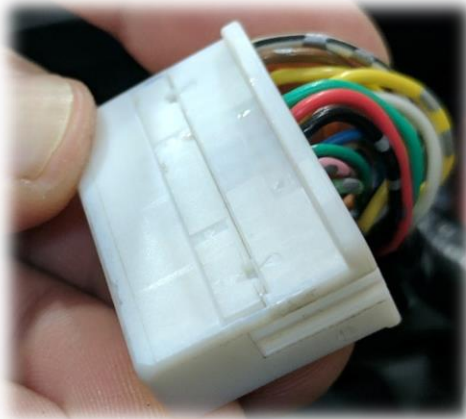

8.b. With a pick tool, pry open the pin-lock tab
NOTE: the tab does not fully remove!

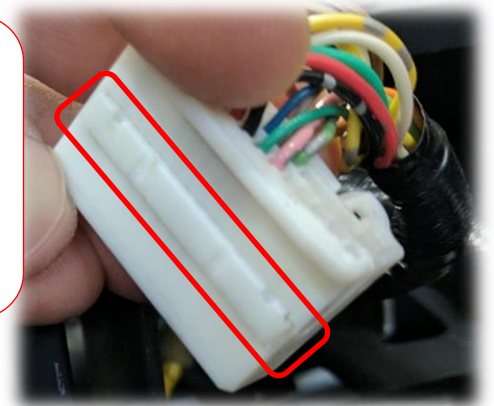

8.c. Insert the RCA shield (black) pin into PIN 15 and the RCA signal (yellow or clear) into PIN 1.

TIP: This may require some careful force, and may require using a pick tool to press the pins in fully so that the lock tab will close.

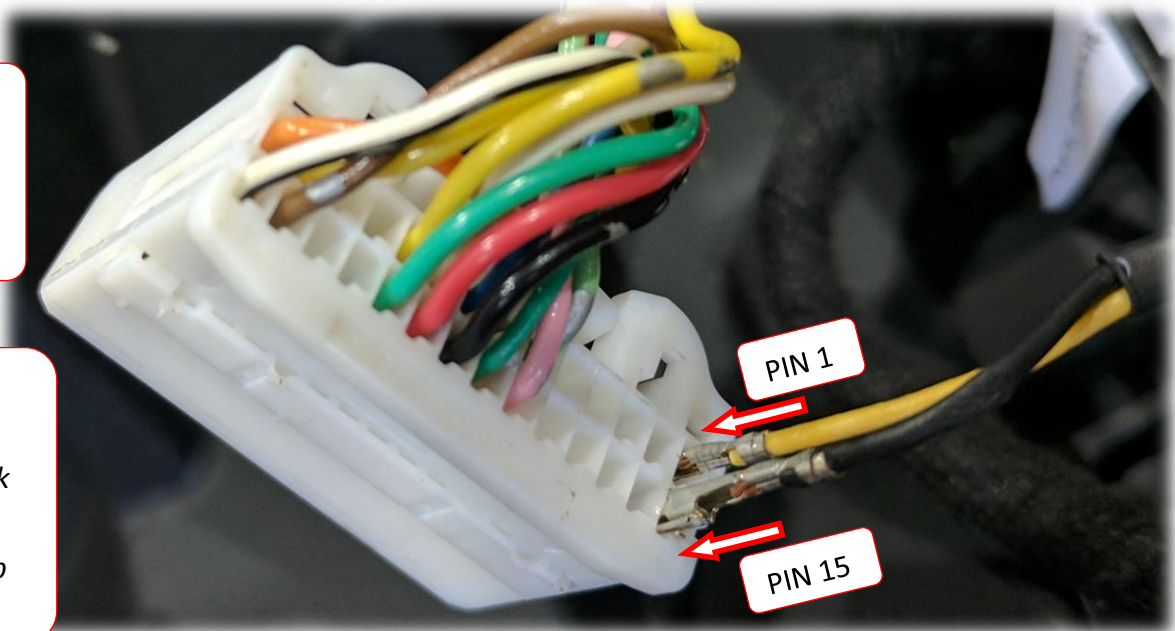

Press the pin-lock tab down on the same connector (from step 8) to secure the pins into the connector.
NOTE: if the tab is not seating, the pins may not be in far enough, or the tab may require force from some pliers to sit down fully.

9. Before mounting the provided **CAM10** and running the cable forwards to the dash opening, test for proper functionality.
10. Before mounting the provided **CAM10** and running the cable forwards to the dash opening, test for proper functionality. Power the camera with the **red wire (PIN 3) from the S2P**. *This step is vital for reliable camera operation for this install.* Ground the camera power to a chassis ground (-) or splice to the same ground on the S2P power harness.

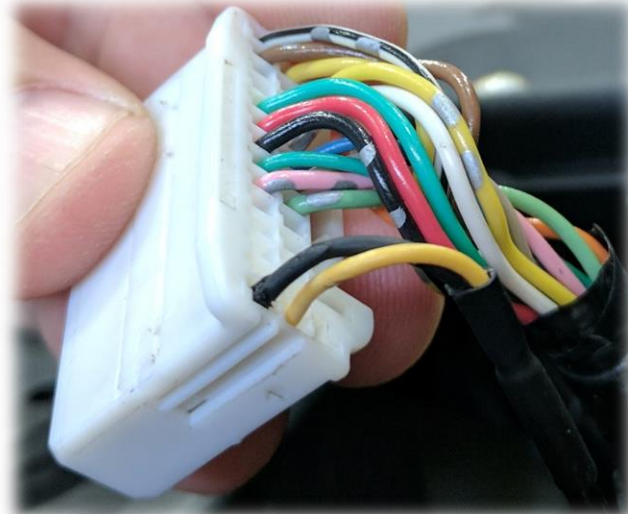

This step is vital for reliable camera operation for this install. Ground the camera power to a chassis ground (-) or splice to the same ground on the S2P power harness.

11. Reconnect all harnesses and replace the radio/screen assembly into the dash, paying close attention not to crush the S2P module in the process.
12. Start the car. Before putting the car into reverse, the Mazda Connect system may need to be reset (1 time only). Perform this step **once the radio is fully booted**:

**Press and hold MUTE
(volume knob inwards) and
NAV until the screen reboots
(about 10 seconds).**

13. Test reverse camera functionality, once confirmed replace all dash pieces back to factory.



Mazda-CAM 2 wiring diagram

Power Connector (18 PIN)

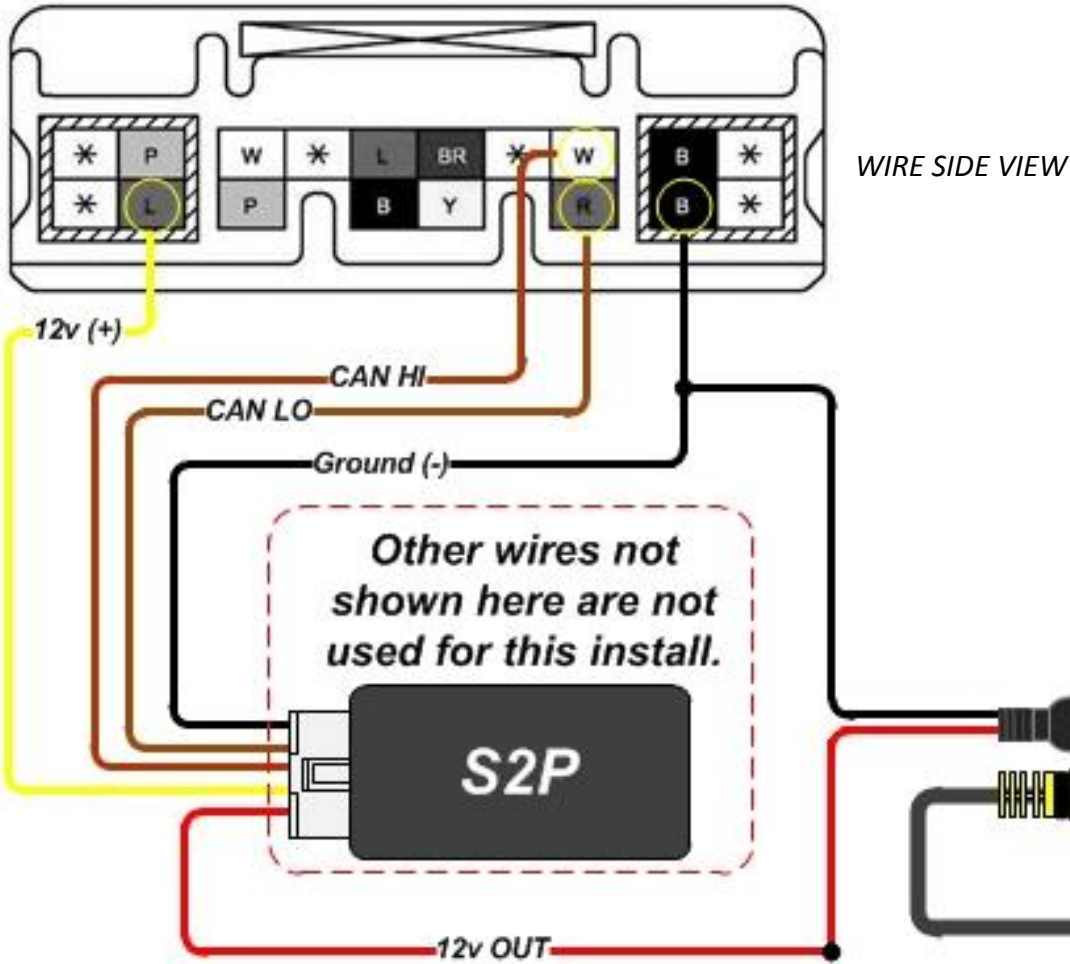

Video IN Connector (28 PIN)

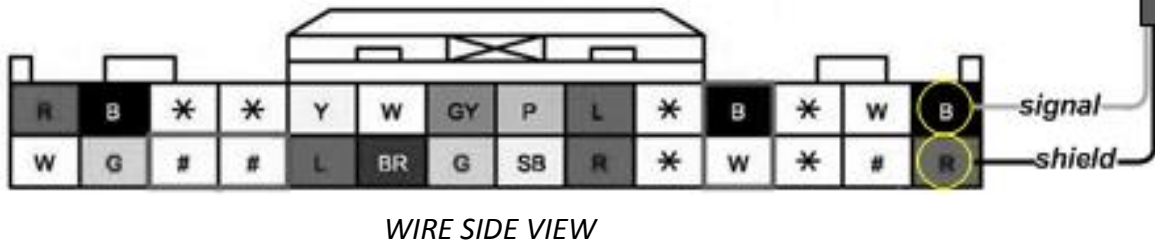

Mazda-CAM 2 Operation

- *Once all connections are made, placing the vehicle into reverse will show the connected camera's image on the main screen.*



NAV-TV

INTERFACING THE FUTURE



Agreement: End user agrees to use this product in compliance with all State and Federal laws. NAV-TV Corp. would not be held liable for misuse of its product. If you do not agree, please discontinue use immediately and return product to place of purchase. This product is intended for off-road use and passenger entertainment only.